



INSTRUCTION MANUAL

VHF MARINE TRANSCEIVER
IC-M36

This device complies with Part 15 of the FCC Rules. Operation is subject to the condition that this device does not cause harmful interference.

Icom Inc.



SAFETY TRAINING INFORMATION



WARNING

Your Icom radio generates RF electromagnetic energy during transmit mode. This radio is designed for and classified as “General Population Use” in an uncontrolled environment.

This radio has been evaluated for compliance at the distance of 2.5 cm (1 inch) with the FCC RF exposure limits for “General Population Use”. In addition, your Icom radio complies with the following Standards and Guidelines with regard to RF energy and electromagnetic energy levels and evaluation of such levels for exposure to humans:

- FCC OET Bulletin 65 Edition 01-01 Supplement C, Evaluating Compliance with FCC Guidelines for Human Exposure to Radio Frequency Electromagnetic Fields.
- American National Standards Institute (C95.1-2005), IEEE Standard for Safety Levels with Respect to Human Exposure to Radio Frequency Electromagnetic Fields, 3 kHz to 300 GHz.
- American National Standards Institute (C95.3-2002), IEEE Recommended Practice for the Measurement of Potentially Hazardous Electromagnetic Fields— RF and Microwave.
- The following accessories are authorized for use with this product. Use of accessories other than those specified may result in RF exposure levels exceeding the FCC requirements for wireless RF exposure.: Belt Clip (MB-109), Rechargeable Li-Ion Battery Pack (BP-252) and Alkaline Battery Case (BP-251).



CAUTION

To ensure that your exposure to RF electromagnetic energy is within the FCC allowable limits for general population use, always adhere to the following guidelines:

- **DO NOT** operate the radio without a proper antenna attached, as this may damage the radio and may also cause you to exceed FCC RF exposure limits. A proper antenna is the antenna supplied with this radio by the manufacturer or antenna specifically authorized by the manufacturer for use with this radio.
- **DO NOT** transmit for more than 50% of total radio use time (“50% duty cycle”). Transmitting more than 50% of the time can cause FCC RF exposure compliance requirements to be exceeded. The radio is transmitting when the “transmit indicator” appears on the LCD. You can cause the radio to transmit by pressing the “PTT” switch.
- **ALWAYS keep** the antenna at least 2.5 cm (1 inch) away from the body when transmitting and only use the Icom belt-clips which are listed on p. 28 when attaching the radio to your belt, etc., to ensure FCC RF exposure compliance requirements are not exceeded. To provide the recipients of your transmission the best sound quality, hold the antenna at least 5 cm (2 inches) from your mouth, and slightly off to one side.

The information listed above provides the user with the information needed to make him or her aware of RF exposure, and what to do to assure that this radio operates within the FCC RF exposure limits of this radio.

Electromagnetic Interference/Compatibility

During transmissions, your Icom radio generates RF energy that can possibly cause interference with other devices or systems. To avoid such interference, turn off the radio in areas where signs are posted to do so. **DO NOT** operate the transmitter in areas that are sensitive to electromagnetic radiation such as hospitals, aircraft, and blasting sites.

IN CASE OF EMERGENCY

If your vessel requires assistance, contact other vessels and the Coast Guard by sending a distress call on Channel 16.

○ **USING CHANNEL 16**

DISTRESS CALL PROCEDURE

1. "MAYDAY MAYDAY MAYDAY."
2. "THIS IS " (name of vessel)
3. Your call sign or other indication of the vessel.
4. "LOCATED AT " (your position)
5. The nature of the distress and assistance required.
6. Any other information which might facilitate the rescue.

RECOMMENDATION

CLEAN THE TRANSCEIVER THOROUGHLY WITH FRESH WATER after exposure to saltwater, and dry it before operation. Otherwise, the transceiver's keys, switches and controllers may become unusable due to salt crystallization.

NOTE: DO NOT wash the transceiver in water if there is any reason to suspect the waterproof protection may not be effective. For example, in cases where the battery pack rubber seal is damaged, the transceiver/battery pack is cracked or broken, or has been dropped, or when the battery pack is detached from the transceiver.

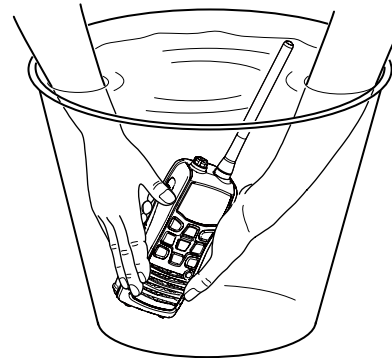

FOREWORD

Thank you for purchasing this Icom radio. The IC-M36 VHF MARINE TRANSCEIVER is designed and built with Icom's state of the art technology and craftsmanship. With proper care this radio should provide you with years of trouble-free operation.

IMPORTANT

READ ALL INSTRUCTIONS carefully and completely before using the transceiver.

SAVE THIS INSTRUCTION MANUAL—This instruction manual contains important operating instructions for the IC-M36.

EXPLICIT DEFINITIONS

WORD	DEFINITION
⚠WARNING	Personal injury, fire hazard or electric shock may occur.
CAUTION	Equipment damage may occur.
NOTE	If disregarded, inconvenience only. No risk of personal injury, fire or electric shock.

FEATURES

Floating on water

The transceiver floats on fresh or salt water even when the supplied accessories are attached.

- When a third-party battery pack, strap, antenna, etc. is used, it may sink.
- The battery contacts may be prone to rust if the transceiver is kept floating on the water.



Clear voice boost

The transceiver has the noise detection function which enables automatic volume adjustment and the volume loud function that enables you to maximize the volume level instantly to provide clear communication in the noisy marine environments.

Noise cancelling microphone

The sub-microphone on the rear panel inverts the phase and cancels out the ambient noise from the main microphone. As a result, the transceiver can reduce the influence of the background noise (particularly treble noise) on the transmitted signal.

- The noise cancellation can produce no effect according to conditions such as loudness and type of noise, or the position and distance between the noise source and the microphone, etc.
- The noise cancellation does not work when an optional external speaker-microphone is connected.

PRECAUTIONS

⚠ WARNING! NEVER connect the transceiver to an AC outlet. This may pose a fire hazard or result in an electric shock.

⚠ WARNING! NEVER hold the transceiver so that the antenna is closer than 2.5 cm (1 inch) from exposed parts of the body, especially the face or eyes, while transmitting. The transceiver will perform best if the microphone is 5 to 10 cm (2 to 4 inches) away from the lips and the transceiver is vertical.

NEVER connect the transceiver to a power source other than the BP-251 (option) or BP-252. Such a connection will ruin the transceiver.

DO NOT use or place the transceiver in direct sunlight or in areas with temperatures below -20°C (-4°F) or above $+60^{\circ}\text{C}$ ($+140^{\circ}\text{F}$).

KEEP the transceiver out of the reach of children.

KEEP the transceiver at least 0.9 meters (3.0 ft) away from your vessel's magnetic navigation compass.

BE CAREFUL! The transceiver's right-side panel will become hot when operating continuously for long periods.

BE CAREFUL! The transceiver meets IPX7* requirements for waterproof protection. However, once the transceiver has been dropped, waterproof protection cannot be guaranteed because of possible damage to the transceiver's case or the waterproof seal.

* Only when the BP-251 (option) or BP-252, flexible antenna, **[SP MIC]** cap is attached.

MAKE SURE the flexible antenna and battery pack are securely attached to the transceiver, and that the antenna and battery pack are dry before attachment. Exposing the inside of the transceiver to water will result in serious damage to the transceiver.

After exposure to water, clean the battery contacts thoroughly with fresh water and dry them completely to remove any water or salt residue.

For U.S.A. only

CAUTION: Changes or modifications to this device, not expressly approved by Icom Inc., could void your authority to operate this device under FCC regulations.

Icom, Icom Inc. and the ICOM logo are registered trademarks of Icom Incorporated (Japan) in the United States, the United Kingdom, Germany, France, Spain, Russia and/or other countries.

TABLE OF CONTENTS

SAFETY TRAINING INFORMATION.....	i	
IN CASE OF EMERGENCY	ii	
RECOMMENDATION	ii	
FOREWORD	iii	
IMPORTANT	iii	
EXPLICIT DEFINITIONS.....	iii	
FEATURES.....	iii	
PRECAUTIONS.....	iv	
TABLE OF CONTENTS.....	v	
1 OPERATING RULES	1	
2 SUPPLIED ACCESSORIES AND ATTACHMENTS.....	2-3	
■ Supplied accessories.....	2	
■ Attachments.....	2	
3 PANEL DESCRIPTION	4-7	
■ Front, top, side and rear panels	4	
■ Function display.....	6	
4 BASIC OPERATION	8-13	
■ Channel selection	8	
■ Receiving and transmitting	10	
■ Call channel programming.....	11	
■ Adjusting the volume level	11	
■ Volume loud function.....	12	
■ Volume mute function	12	
■ Adjusting the squelch level	12	
■ Lock function.....	13	
■ Monitor function	13	
■ Automatic backlighting.....	13	
■ AquaQuake water draining function.....	13	
5 SCAN OPERATION	14-15	
■ Scan types.....	14	
■ Setting TAG channels	15	
■ Starting a scan.....	15	
6 DUALWATCH/TRI-WATCH	16	
■ Description.....	16	
■ Operation	16	
7 SET MODE.....	17-20	
■ Set mode programming	17	
■ Set mode items.....	18	
8 BATTERY CHARGING	21-24	
■ Battery caution.....	21	
■ Supplied battery charger	23	
■ Optional battery case.....	23	
■ Optional battery charger	24	
9 OPTIONAL SPEAKER-MICROPHONE.....	25	
■ HM-165 descriptions.....	25	
■ Attachment.....	25	
10 TROUBLESHOOTING	26	
11 VHF MARINE CHANNEL LIST.....	27	
12 SPECIFICATIONS AND OPTIONS.....	28	
■ Specifications.....	28	
■ Options	28	
13 FCC INFORMATION	29	

◇ **Priorities**

- Read all rules and regulations pertaining to priorities and keep an up-to-date copy handy. Safety and distress calls take priority over all others.
- You must monitor Channel 16 when you are not operating on another channel.
- False or fraudulent distress calls are prohibited under law.

◇ **Privacy**

- Information overheard but not intended for you cannot lawfully be used in any way.
- Indecent or profane language is prohibited.

◇ **Radio licenses**

(1) SHIP STATION LICENSE

You must have a current radio station license before using the transceiver. It is unlawful to operate a ship station which is not licensed.

Inquire through your dealer or the appropriate government agency for a Ship-Radiotelephone license application. This government-issued license states the call sign which is your craft's identification for radio purposes.

(2) OPERATOR'S LICENSE

A Restricted Radiotelephone Operator Permit is the license most often held by small vessel radio operators when a radio is not required for safety purposes.

The Restricted Radiotelephone Operator Permit must be posted or kept with the operator. Only a licensed radio operator may operate a transceiver.

However, non-licensed individuals may talk over a transceiver if a licensed operator starts, supervises, ends the call and makes the necessary log entries.

A current copy of the applicable government rules and regulations is only required to be on hand for vessels in which a radio telephone is compulsory. However, even if you are not required to have these on hand it is your responsibility to be thoroughly acquainted with all pertinent rules and regulations.

NOTE: Even though the IC-M36 is capable of operation on VHF marine channels 3, 21, 23, 61, 64, 81, 82 and 83, according to FCC regulations these simplex channels cannot be lawfully used by the general population in U.S.A. waters.

■ Supplied accessories

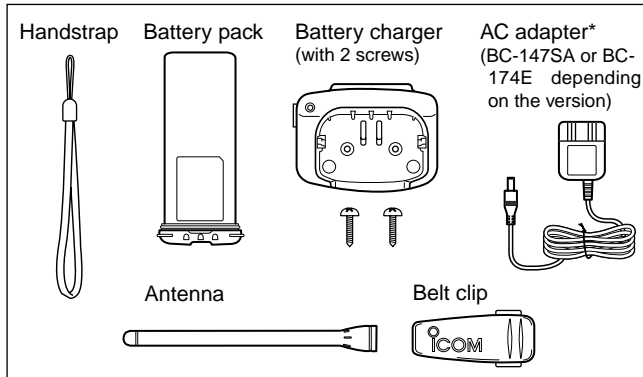

* This illustration is described with the BC-147SA.

■ Attachments

◇ Flexible antenna

Connect the supplied flexible antenna to the antenna connector.

CAUTION!

- NEVER carry the transceiver by holding the antenna.
- Transmitting without an antenna may damage the transceiver.

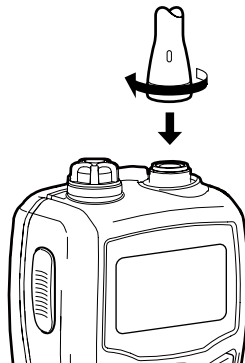

◇ Handstrap

Pass the handstrap through the loop on the back side of the transceiver as illustrated at right. This facilitates carrying.

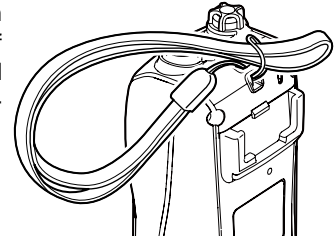

◇ Belt clip

Attach/detach the belt clip to the transceiver as illustrated below.

To attach the belt clip

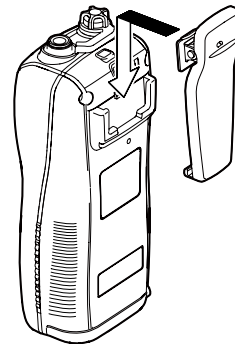

To detach the belt clip



◆ Battery pack

To remove the battery pack:

Turn the screw counter clockwise one quarter turn, then pull the battery pack in the direction of the arrow as shown below.

To attach the battery pack:

Insert the battery pack in the transceiver completely, then turn the screw clockwise one quarter turn.

NEVER remove or insert the battery pack when the transceiver is wet or soiled. This may result water or dust getting into the transceiver/battery pack and may result in the transceiver being damaged.

NOTE: When removing or attaching the battery pack, use a coin or standard screwdriver to loosen or tighten the bottom screw.

CAUTION! When attaching or removing a battery pack, make sure the rubber seal is set in the groove of the battery pack correctly. If the seal is not correctly in the groove, it may be damaged when attaching the battery pack. If the seal is damaged, waterproof protection is not guaranteed.

NOTE: When attaching a battery pack, make sure dust or other material does not adhere to the rubber seal. If dust or other material is on the seal when attaching a battery pack, waterproof protection may not be guaranteed.

Make sure the rubber seal (purple) is properly seated in the groove and dust or other material does not adhere to it.

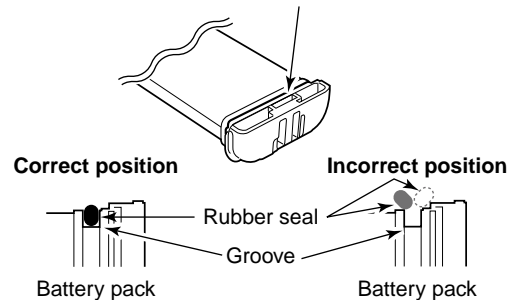
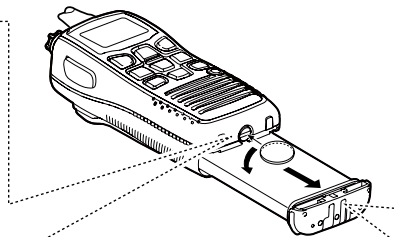
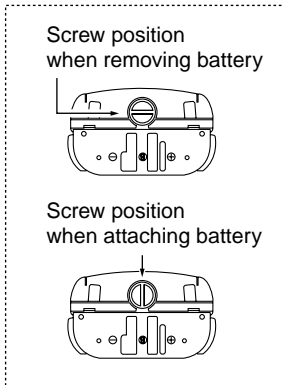

3

PANEL DESCRIPTION

■ Front, top, side and rear panels

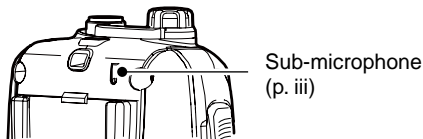
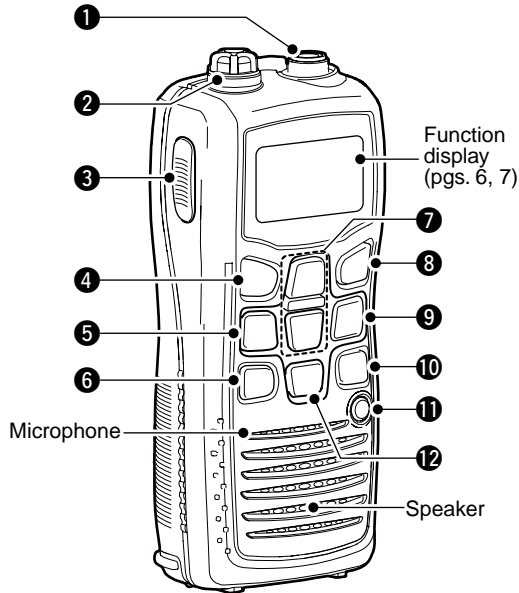

① ANTENNA CONNECTOR (p. 2)

Connects the supplied antenna.

② SPEAKER-MICROPHONE CONNECTOR [SP MIC] (p. 25)

Connects the optional external speaker-microphone.

NOTE: Attach the [SP MIC] cap when the optional speaker-microphone is not used. Otherwise, water will get into the transceiver.

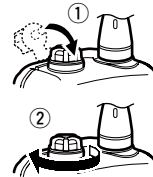

① Attach the [SP MIC] cap.

② Then rotate it clockwise completely.

③ PTT SWITCH [PTT]

Push and hold to transmit; release to receive. (p. 10)

④ CHANNEL 16 KEY [16 9]

➔ Push to select Channel 16. (p. 8)

➔ Push and hold for 1 sec. to select the call channel. (p. 8)

➔ When the call channel is selected, push and hold for 3 sec. to enter the call channel programming mode. (p. 11)

➔ While in the set mode, push to return to the normal condition. (p. 17)

5 VOLUME/SQUELCH/MONITOR KEY [VOL/SQL MONI]

- Push to enter the volume adjustment mode and the squelch adjustment mode. (pgs. 11, 12)

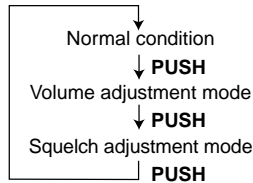

- Push to restore the changed volume level by the noise detection, volume loud, or volume mute function to the original. (pgs. 12, 20)
- Push and hold for 1 sec. to activate the monitor function. (p. 13)
- While pushing and holding this key, turn power ON to enter the set mode. (p. 17)
- While in the set mode, push to select an item. (p. 17)

6 SCAN/DUAL KEY [SCAN DUAL]

- Push to start or stop normal or priority scan. (p. 15)
- Push and hold for 1 sec. to enter the watch mode. (p. 16)
- Push to exit the watch mode. (p. 16)
- Push and hold this key and [Hi/Lo , to activate the AquaQuake function. (p. 13)

7 CHANNEL UP/DOWN KEYS [▲]/[▼]

- Selects an operating channel. (pgs. 8, 9)
- While in the set mode, selects the setting or value of an item. (p. 17)
- Checks TAG channels or changes scanning direction during scan. (p. 15)

8 FAVORITE/TAG KEY [FAV TAG]

- Push this key to select the favorite (TAG) channels with ignoring untagged channels in a channel group in sequence. (p. 8)
- Push and hold for 1 sec. to set or clear TAG for the displayed channel. (p. 15)
- While pushing and holding this key, turn power ON to clear or set all TAG channels in the selected channel group. (p. 15)

9 CHANNEL/WEATHER CHANNEL KEY [CH/WX U/I/C]

- Push to switch between the regular channel and weather channel. (p. 9)
- Push and hold for 1 sec. to select the channel group from U.S.A., International and Canada. (p. 9)
- Push to return to the previous channel before selecting Channel 16 or the call channel.

10 TRANSMIT POWER/LOCK KEY [Hi/Lo 

- Push to select the output power from high and low. (p. 10)
- Push and hold for 1 sec. to turn the key lock function ON or OFF. (p. 13)

11 POWER KEY [

- Push and hold to turn power ON or OFF.

12 LOUD/MUTE KEY [LOUD MUTE]

- Push to turn the volume loud function ON or OFF. (p. 12)
- Push and hold for 1 sec. to turn the volume mute function ON, and push to turn the function OFF. (p. 12)

3 PANEL DESCRIPTION

■ Function display

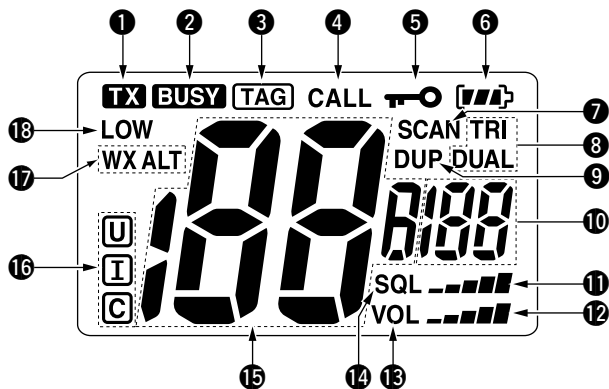

1 TRANSMIT INDICATOR (p. 10)

Appears while transmitting.

2 BUSY INDICATOR

➔ Appears when receiving a signal or when the squelch opens. (p. 10)

➔ Blinks while monitoring. (p. 13)

3 TAG CHANNEL INDICATOR (p. 15)

Appears when a TAG channel is selected.

4 CALL CHANNEL INDICATOR (p. 8)

Appears when the call channel is selected.

5 LOCK INDICATOR (p. 13)

Appears while the lock function is activated.

6 BATTERY INDICATOR

Indicates remaining battery power.

Indication	[]	[]	[]	[]
Battery level	Full	Middle	Charging required	No battery

[|||||] blinks when the battery is over charged.

[|] blinks when the battery is exhausted.

7 SCAN INDICATOR (p. 15)

Blinks during scan.

8 DUALWATCH/TRI-WATCH INDICATORS (p. 16)

“DUAL” appears during Dualwatch; “TRI” appears during Tri-watch.

9 DUPLEX INDICATOR

Appears when a duplex channel is selected.

10 SUB CHANNEL READOUT

➔ Indicates Channel 16 during priority scan, Dualwatch or Tri-watch. (p. 16)

➔ Indicates the set mode item while in the set mode. (p. 17)

➔ Indicates the volume level while in the volume adjustment mode. (p. 11)

➔ Indicates the squelch level while in the squelch adjustment mode. (p. 12)

11 SQUELCH LEVEL INDICATOR

Shows the squelch level.

12 VOLUME LEVEL INDICATOR

➤ Shows the volume level.

➤ The bars appear in ascending order repeatedly when the volume loud function is activated. (p. 12)

➤ Blinks while the volume mute is activated. (p. 12)

13 VOLUME LEVEL ADJUSTING INDICATOR (p. 11)

➤ Blinks while adjusting the volume level.

➤ This indicator and the volume level indicator appear alternately while the volume level is turned up by the noise detection function. (p. 20)

14 SQUELCH LEVEL ADJUSTING INDICATOR (p. 12)

Blinks while adjusting the squelch level.

15 CHANNEL NUMBER READOUT

➤ Indicates the selected operating channel number.

➤ In the set mode, indicates the selected condition or value. (p. 17)

16 CHANNEL GROUP INDICATOR (p. 9)

“**U**” appears when U.S.A.; “**I**” appears when International; “**C**” appears when Canadian channel group is selected each.

17 WEATHER CHANNEL/WEATHER ALERT INDICATORS

(p. 9)

➤ “**WX**” appears when the weather channel group is selected.

➤ “**WX ALT**” appears while the weather alert function is activated; blinks when the alert tone is received.

18 LOW POWER INDICATOR (p. 10)

➤ “**LOW**” appears when low power is selected.

➤ “**LOW**” blinks when switching forced low power mode because of a high temperature error or low voltage.

■ Channel selection

IMPORTANT! Prior to using the transceiver for the first time, the battery pack must be fully charged for optimum life and operation. To avoid damage to the transceiver, turn the power OFF while charging.

◇ Channel 16

Channel 16 is the distress and safety channel. It is used for establishing initial contact with a station and for emergency communications. Channel 16 is monitored during both Du-alwatch and Tri-watch. While in the standby condition, you must monitor Channel 16.

- ① Push **[16 9]** momentarily to select Channel 16.
- ② Push **[CH/WX U/I/C]** to return to the channel used before Channel 16, or push **[▲]/[▼]** to select a channel.

Push

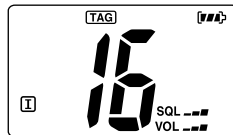

Convenient!

While pushing and holding **[FAV TAG]**, push **[▲]/[▼]** to select the favorite (TAG) channels with ignoring untagged channels in the selected channel group in sequence.

- Pushing **[FAV TAG]** only advances the displayed TAG channel.
- The favorite channels are selected using the TAG channel setting. (p. 15)

◇ Channel 9 (Call channel)

Each regular channel group has separate leisure-use call channels. The call channel is monitored during Tri-watch. The call channels can be programmed (p. 11) and are used to store your most often used channel in each channel group for quick recall.

- ① Push and hold **[16 9]** for 1 sec. to select the call channel of the selected channel group.
 - **CALL** and call channel number appear.
 - Each channel group may have an independent callchannel after programming a call channel. (p. 11)
- ② Push **[CH/WX U/I/C]** to return to the channel used before call channel, or push **[▲]/[▼]** to select a channel.

Push and hold for 1 sec.



◇ **U.S.A., International and Canadian channels**

The transceiver is pre-programmed with 59 U.S.A., 59 International and 63 Canadian channels. These channel groups may be specified for the operating area.

- ① Push **[CH/WX U/I/C]** to select a regular channel.
 - If a weather channel appears, push **[CH/WX U/I/C]** again.
- ② Push and hold **[CH/WX U/I/C]** for 1 sec. to change the channel group. Repeat to advance to the next group.
 - U.S.A., International and Canadian channel groups can be selected in sequence.
- ③ Push **[▲]/[▼]** to select a channel.
 - **DUP** appears for duplex channels.

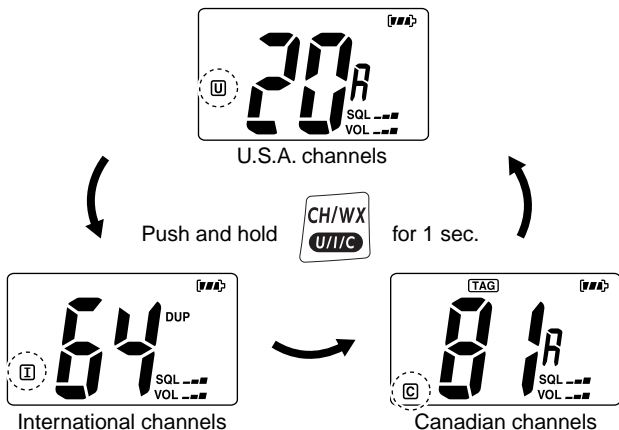

◇ **Weather channels**

The transceiver has 10 pre-programmed weather channels. These are used for monitoring broadcasts from the NOAA (National Oceanic and Atmospheric Administration).

The transceiver can automatically detect a weather alert tone on the selected weather channel while receiving another channel or during scan. (p. 18)

- ① Push **[CH/WX U/I/C]** once or twice to select a weather channel.
 - **WX** appears when a weather channel is selected.
 - **WX ALT** appears when the weather alert function is turned ON. (p. 18)
- ② Push **[▲]/[▼]** to select a weather channel.

Push **[CH/WX U/I/C]** once or twice.

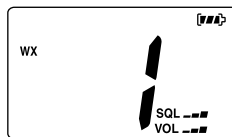

Weather alert is OFF.

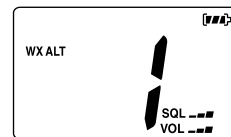

Weather alert is ON.

4 BASIC OPERATION

■ Receiving and transmitting

CAUTION: Transmitting without an antenna may damage the transceiver.

- ① Push and hold [⏻] to turn power ON.
- ② Set the volume and squelch levels.
You can enter each adjust mode with [VOL/SQL MONI].
 - ➔ Enter the squelch adjustment mode, and push [▼] several times to open the squelch.
 - ➔ Enter the volume adjustment mode, then push [▲]/[▼] to adjust the volume level.
 - ➔ Enter the squelch adjustment mode again, and push [▲] until the noise disappears.
- ③ Push [▲]/[▼] to select the desired channel.
 - When receiving a signal, "BUSY" appears and audio is emitted from the speaker.
 - Further adjustment of the audio may be necessary at this point.
- ④ Push [Hi/Lo] to select the output power if necessary.
 - "LOW" appears when low power is selected; no indication when high power is selected.
 - Choose low power for short range communications, choose high power for longer distance communications.
 - Some channels are for low power only.
- ⑤ Push and hold [PTT] to transmit, then speak into the microphone.
 - "TX" appears.
 - Channel 70 cannot be used for transmission.
- ⑥ Release [PTT] to receive.

IMPORTANT: To maximize the readability of your transmitted signal, pause a few sec. after pushing [PTT], hold the microphone 5 to 10 cm (2 to 4 inches) from your mouth and speak into the microphone at a normal voice level.

NOTE: The transceiver has a power save function to conserve the battery power. The power save function activates automatically when no signal is received for 5 sec.

For U.S.A version: To prevent accidental prolonged transmission, etc., the transceiver has a time-out timer function. This timer cuts a transmission OFF after 5 min. of continuous transmission.

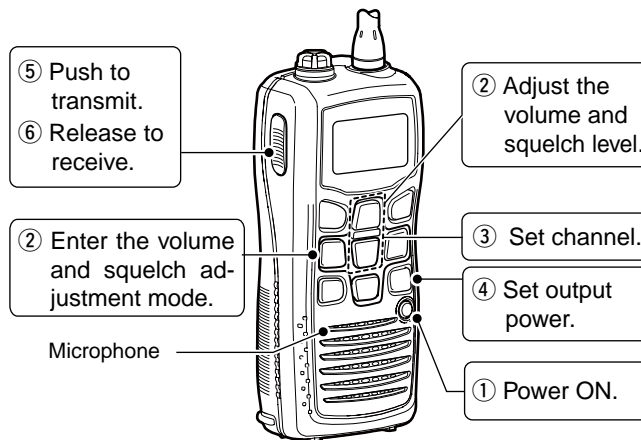

■ Call channel programming

Call channel is used to access Channel 9 (default), however, you can program the call channel with your most often-used channels in each channel group for quick recall.

- ① Push and hold **[CH/WX U//C]** for 1 sec. several times to select the desired channel group (U.S.A., International or Canada) to be programmed. (p. 9)
- ② Push and hold **[16 9]** for 1 sec. to select the call channel of the selected channel group.
 - **CALL** and call channel number appear.
- ③ Push and hold **[16 9]** again for 3 sec. (until a long beep changes to 2 short beeps) to enter the call channel programming mode.
 - Channel number starts blinking.
- ④ Push **[▲]/[▼]** to select the desired channel.
- ⑤ Push **[16 9]** to program the displayed channel as the call channel.
 - The channel number stops blinking.

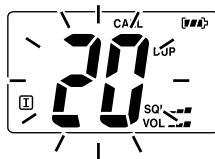
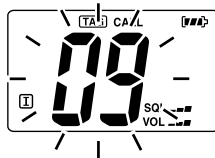

■ Adjusting the volume level

The volume level can be adjusted with **[VOL/SQL MONI]** and **[▲]/[▼]**.

- ① Push **[VOL/SQL MONI]** once to enter the volume adjustment mode, then adjust the volume level with **[▲]/[▼]**.
 - **VOL** indicator starts blinking.
 - The transceiver has 31 volume levels and OFF.
 - With no key operation is performed for 5 sec., the transceiver returns to the normal condition.
- ② Push **[VOL/SQL MONI]** twice to exit the volume adjustment mode.



Indicates the volume level.

Blinks while adjusting the volume level.

4 BASIC OPERATION

■ Volume loud function

The volume loud function can be activated temporarily by pushing **[LOUD MUTE]**.

⚡ The function does not work when the volume level is 31.

- ① Push **[LOUD MUTE]** to activate the volume loud function.
 - The volume level is set to the maximum level (level 31).
 - The bars of the volume level indicator appears in ascending order repeatedly.
- ② Push **[LOUD MUTE]** again, or push **[VOL/SQL MONI]** to turn the volume loud function OFF.

■ Volume mute function

The volume mute function can be activated temporarily by pushing and holding **[LOUD MUTE]**.

⚡ The function does not work when the volume level is OFF.

- ① Push and hold **[LOUD MUTE]** for 1 sec. to activate the volume mute function.
 - The volume level is set to the minimum level (OFF).
 - The volume level indicator blinks.
- ② Push **[LOUD MUTE]** again, or push **[VOL/SQL MONI]** to turn the volume mute function OFF.

■ Adjusting the squelch level

The squelch level can be adjusted with **[VOL/SQL MONI]** and **[▲]/[▼]**.

In order to receive signals properly, as well as for the scan to function effectively, the squelch must be adjusted to the proper level.

- ① Push **[VOL/SQL MONI]** twice to enter the squelch adjustment mode, then adjust the squelch level with **[▲]/[▼]**.
 - **SQL** indicator starts blinking.
 - The transceiver has 11 squelch levels: OP is completely open; 10 is tight squelch; 1 is loose squelch.
 - With no key operation is performed for 5 sec., the transceiver returns to the normal condition.
- ② Push **[VOL/SQL MONI]** again to exit the squelch adjustment mode.

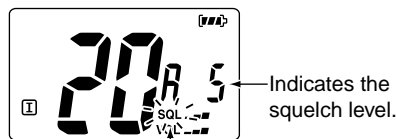

Blinks while adjusting the squelch level.

■ Lock function

This function electronically locks all keys (except for [PTT], [VOL/SQL MONI], [LOUD MUTE], [Hi/Lo ) and [▲]/[▼]*) to prevent accidental channel changes and function access.

* In the volume or squelch adjustment mode only.

- ➔ Push and hold [Hi/Lo ) for 1 sec. to turn the lock function ON and OFF.

Appears while the lock function is activated.

Push and hold
for 1 sec.

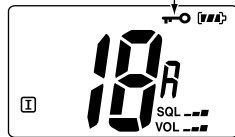

■ Monitor function

The monitor function opens the squelch. The monitor key action can be selected in the set mode. (p. 19)

- ➔ The monitor function is activated by pushing and holding [VOL/SQL MONI] for 1 sec.
 - **BUSY** blinks and the squelch is opened.

Blinks while the monitor function is activated.

Push and hold
for 1 sec.

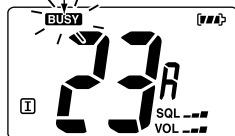

■ Automatic backlighting

This function lights the function display and keys, and it is convenient for night-time operation. The automatic backlighting can be activated in the set mode. (p. 19)

- ➔ Push any key except for [PTT] to turn the backlight ON.
 - The backlight is automatically turned OFF after 5 sec. of inactivity.

■ AquaQuake water draining function

The AquaQuake water draining function clears water away from the speaker grill. Without this function, water may muffle the sound coming from the speaker. The transceiver emits a vibrating beep when this function is activated.

- ➔ Push and hold both [SCAN DUAL] and [Hi/Lo ].
 - A low beep tone sounds for 9 sec. to drain water, regardless of the volume level setting.
 - The transceiver never accepts key operation while the AquaQuake function is activated.
 - The AquaQuake function can not be activated when an optional speaker-microphone is connected.

■ Scan types

Scanning is an efficient way to locate signals quickly over a wide frequency range. The transceiver has priority scan and normal scan.

In addition, the weather alert and auto scan functions are available for standby convenience. These functions can be activated simultaneously, depending on the setting in the set mode. (pgs. 18, 19)

PRIORITY SCAN

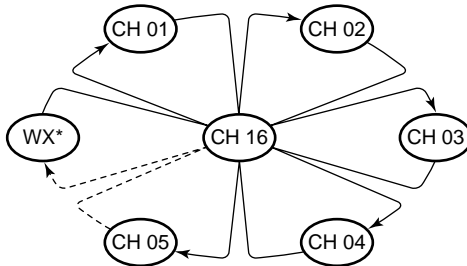

* Previously selected weather channel.
(when the weather alert function is activated)

Priority scan searches through all TAG channels in sequence while monitoring Channel 16. When a signal is detected on Channel 16, scan pauses until the signal disappears; when a signal is detected on a channel other than Channel 16, scan becomes Dualwatch until the signal disappears.

Set the TAG channels (scanned channels) before scanning. Clear the TAG for unwanted channels which inconveniently stop scanning, such as those for digital communications. (p. 15)

/// Choose the desired scan type from "Priority" or "Normal" in the set mode. (p. 18)

NORMAL SCAN

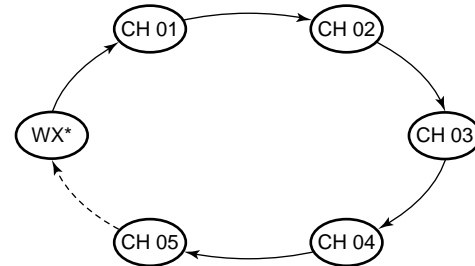

* Previously selected weather channel.
(when the weather alert function is activated)

Normal scan, like priority scan, searches through all TAG channels in sequence. However, unlike priority scan, Channel 16 is not checked unless Channel 16 is set as a TAG channel.

■ Setting TAG channels

For more efficient scanning, add the desired channels as TAG channels or clear TAG for unwanted channels.

Channels that are not tagged will be skipped during scanning. TAG channels can be assigned to each channel group (U.S.A., International and Canada) independently.

- ① Push and hold **[CH/WX U/I/C]** for 1 sec. several times to select the desired channel group.
- ② Select the desired channel to be set as a TAG channel.
- ③ Push and hold **[FAV TAG]** for 1 sec. to set the displayed channel as a TAG channel.
 - **[TAG]** appears on the display.
- ④ To cancel TAG channel setting, push and hold **[FAV TAG]** for 1 sec.
 - **[TAG]** disappears.

✓ Clearing (or setting) all tagged channels

While pushing and holding **[FAV TAG]**, turn power ON to clear all TAG channels in the selected channel group.

- Repeat above procedure to set all channels as TAG channels (when no TAG channel has been set.)

■ Starting a scan

Set the weather alert function, priority scan function, scan resume timer and auto scan function in advance, using the set mode. (pgs. 18, 19)

- ① Push and hold **[CH/WX U/I/C]** for 1 sec. several times to select the desired channel group.
 - When the weather alert function is in use, select the desired weather channel with **[CH/WX U/I/C]** and **[▲]/[▼]**.
- ② Push **[SCAN DUAL]** to start priority or normal scan.
 - **[SCAN]** blinks in the display.
 - “16” appears on the sub channel readout during priority scan.
 - When a signal is received, scan pauses until the signal disappears or resumes after pausing 5 sec. according to the set mode setting.
 - Push **[▲]/[▼]** to check which channels have been set as TAG channels, change the scanning direction or resume the scan manually.
- ③ To stop the scan, push **[SCAN DUAL]**.
 - **[SCAN]** disappears.
 - Pushing **[PTT]**, **[16 9]**, **[CH/WX U/I/C]** or **[FAV TAG]** also stops the scan.

[Example]: Starting a normal scan.

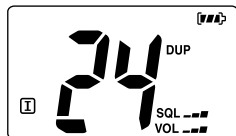

Push



Scan starts

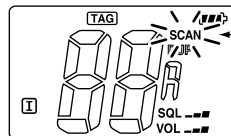

Blinks

When a signal is received

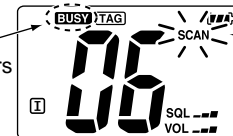

Appears

Blinks

■ Description

Dualwatch monitors Channel 16 while you are receiving on another channel; Tri-watch monitors Channel 16 and the call channel while receiving another channel. Dualwatch/Tri-watch is convenient for monitoring Channel 16 when you are operating on another channel.

DUALWATCH/TRI-WATCH SIMULATION

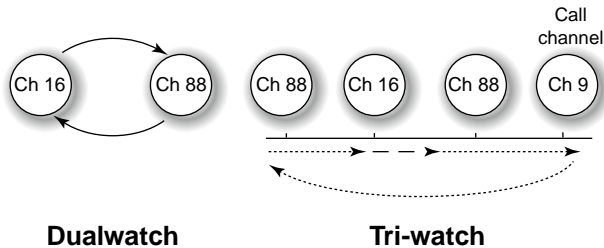

- If a signal is received on Channel 16, Dualwatch/Tri-watch pauses on Channel 16 until the signal disappears.
- If a signal is received on the call channel during Tri-watch, Tri-watch becomes Dualwatch until the signal disappears.
- $\bar{0}$ transmit on the selected channel during Dualwatch/Tri-watch, push and hold [PTT].

■ Operation

- ① Select Dualwatch or Tri-watch in the set mode. (p. 19)
- ② Select the desired channel.
- ③ Push and hold [SCAN DUAL] for 1 sec. to start Dualwatch or Tri-watch (depending on the set mode setting).
 - **DUAL** blinks during Dualwatch; **TRI** blinks during Tri-watch.
 - A beep tone sounds when a signal is received on Channel 16.
 - Tri-watch becomes Dualwatch when receiving a signal on the call channel.
- ④ To cancel Dualwatch/Tri-watch, push [SCAN DUAL] again.

[Example]: Operating Tri-watch on INT channel 07.

Tri-watch starts.

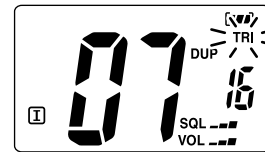

Signal is received on call channel.



Tri-watch resumes after the signal disappears.



Signal received on Channel 16 takes priority.

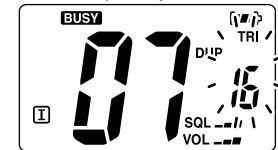

■ Set mode programming

Set mode is used to change the conditions of transceiver's functions: Beep tone function, Weather alert function, Priority scan function, Scan resume timer, Auto scan function, Monitor key action, Automatic backlighting, LCD contrast setting, Power save function, Squelch sensitivity, Low fix function* and Noise detection function.

*Appears only when the optional battery case is attached.

◇ Set mode operation

- ① Turn power OFF.
- ② While pushing [VOL/SQL MONI], turn power ON to enter the set mode.
 - "bP" appears.
- ③ Push [VOL/SQL MONI], or push [▲]/[▼] while pushing and holding [VOL/SQL MONI] to select the desired item.
- ④ Push [▲]/[▼] to select the desired condition of the item.
- ⑤ To exit the set mode, push [16 9].

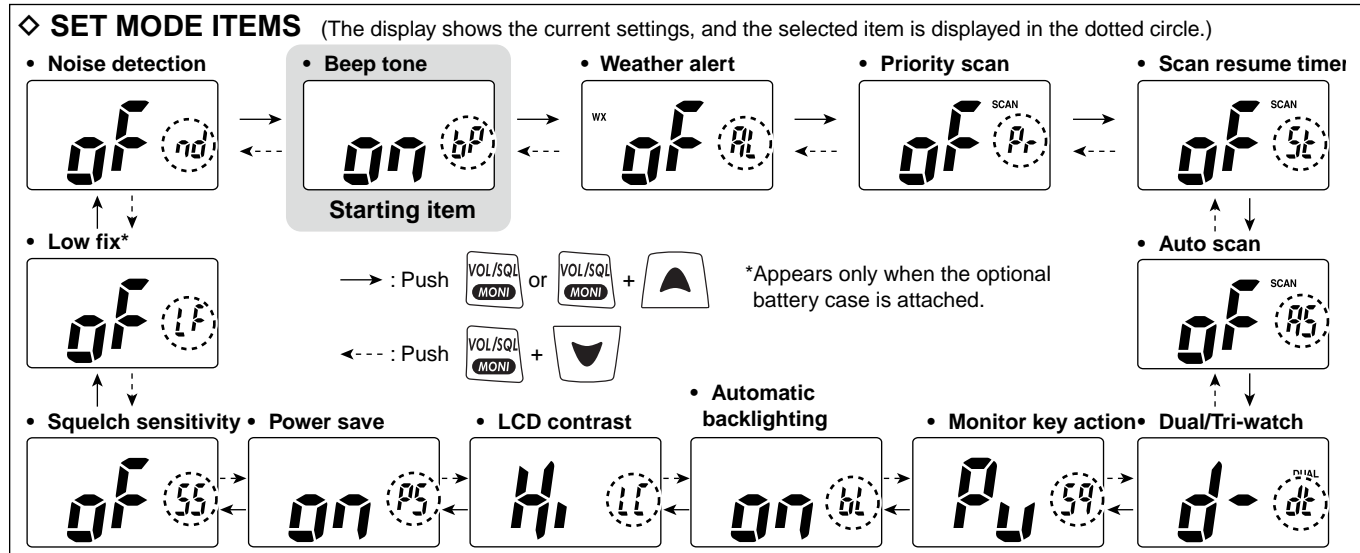

■ Set mode items

◇ Beep tone function

“bP”

Select the key touch beep sound from ON or US, or turn sound OFF.

- OFF: For silent operation.
- ON : A fixed beep sounds.
- US : The preset beeps (e.g. do, re, mi) sound.



Beep tone ON (default)



Beep tone OFF

◇ Weather alert function

“AL”

A NOAA broadcast station transmits a weather alert tone before any important weather announcements. When the function is turned ON and the transceiver detect a weather alert tone, “WX ALT” indicator blinks and the transceiver emits a beep. The blinking stops when the transceiver is operated. The currently selected weather channel is checked while the power save function is activated or during scan.

- “ALT” appears when the function is set ON.



Weather alert function OFF (default)



Weather alert function ON

◇ Priority scan function

“Pr”

The transceiver has 2 scan types— normal (OFF) and priority (ON) scans. Normal scan searches all TAG channels in the selected channel group. Priority scan searches all TAG channels in sequence while monitoring Channel 16.



Normal scan (default)

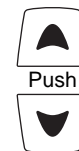

Priority scan

◇ Scan resume timer

“St”

The scan resume timer can be set as a pause (OFF) or timer scan (ON).

- OFF: When a signal is detected on a channel, scan pauses on the channel until the signal disappears, and then resumes.
- ON : When a signal is detected on a channel, scan pauses on the channel for 5 sec., and then resumes.



Scan resume timer OFF (default)



Scan resume timer ON

◇ **Auto scan function**

“AS”

The auto scan function starts normal or priority scan automatically when no signal is received, and no operation is performed for 30 sec.



Auto scan OFF (default)

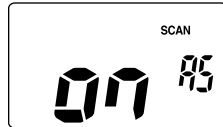

Auto scan ON

◇ **Dual/Tri-watch function**

“dt”

This item can be set as Dualwatch or Tri-watch. (p. 16)

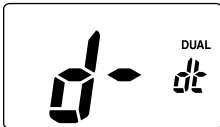

Dualwatch function
(default)

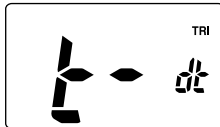

Tri-watch function

◇ **Monitor key action**

“Sq”

The monitor key opens the squelch temporarily. This item sets the key action.

- Pu (PUSH) : The monitor function is activated by pushing and holding [VOL/SQ L MONI] for 1 sec. The squelch opens while holding down the key.
- Ho (HOLD) : The monitor function is activated by pushing and holding [VOL/SQ L MONI] for 1 sec. The squelch stays open until any key is pushed.



Push setting (default)



Hold setting

◇ **Automatic backlighting**

“bL”

This function is convenient for night-time operation. The backlight can be selected from ON and OFF.

- The backlight is automatically activated when anykey except for [PTT] is pushed.
- The backlight is automatically turned OFF after 5 sec. of inactivity.



Auto backlighting ON
(default)



Auto backlighting OFF

◇ **LCD contrast setting**

“LC”

Set the LCD contrast level from High contrast and Low contrast.

⚡ The LCD contrast level makes no difference for indoor use.



High contrast (default)



Low contrast

7 SET MODE

◇ Power save function “PS”

The power save function reduces current drain by deactivating the receiver circuit for preset intervals.

- OFF : The power save function is turned OFF.
- ON : The power save function is turned ON. The power save function will be activated when no signal is received, and no operation is performed for 5 sec.



Power save ON
(default)

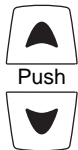

Power save OFF

◇ Squelch sensitivity “SS”

When this function is turned ON, rejection of noise is improved so that the audio is not easily affected by noise.



Squelch sensitivity
OFF (default)



Squelch sensitivity
ON

◇ Low fix function “LF”

(Appears only when the optional battery case is attached.)

When this function is turned ON, the output power is fixed to low except for Channel 16.



Low fix function
OFF (default)

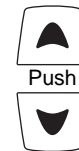

Low fix function ON

◇ Noise detection function “nd”

The noise detection function enables the transceiver to detect the ambient noise while in the standby condition. If the detecting noise and the received signal are stronger than the specific level, the transceiver increases the volume level automatically to suit the environment when receiving a signal.

/// When the squelch is open, the transceiver won't detect noise.

- OFF : The noise detection function is turned OFF.
- Low : When the detecting noise is louder than the specific level, the transceiver turns up the volume.
- High : When the detecting noise is louder than the specific level, the transceiver turns up the volume greater than "Low" setting.



Noise detection function
OFF (default)



Noise detection function
ON (High)

■ Battery caution

Misuse of Lithium-Ion batteries may result in the following hazards: smoke, fire, or the battery may rupture. Misuse can also cause damage to the battery or degradation of battery performance.

⚠ **DANGER!** Use and charge only specified Icom battery pack with Icom radios or Icom charger. Only Icom battery pack is tested and approved for use and charge with Icom radios or Icom charger. Using third-party or counterfeit battery packs or charger may cause smoke, fire, or cause the battery to burst.

◇ Battery caution

⚠ **DANGER! DO NOT** hammer or otherwise impact the battery. Do not use the battery if it has been severely impacted or dropped, or if the battery has been subjected to heavy pressure. Battery damage may not be visible on the outside of the case. Even if the surface of the battery does not show cracks or any other damage, the cells inside the battery may rupture or catch fire.

⚠ **DANGER! NEVER** use or leave battery pack in areas with temperatures above +60°C (+140°F). High temperature buildup in the battery, such as could occur near fires or stoves, inside a sun-heated car, or by setting the battery in direct sunlight may cause the battery to rupture or catch fire. Excessive temperatures may also degrade battery performance or shorten battery life.

⚠ **DANGER! DO NOT** expose the battery to rain, snow, saltwater, or any other liquids. Never charge or use a wet battery. If the battery gets wet, be sure to wipe it dry before using. The battery by itself is not waterproof.

⚠ **DANGER! NEVER** incinerate a used battery pack since internal battery gas may cause them to rupture or may cause an explosion.

⚠ **DANGER! NEVER** solder the battery terminals, or **NEVER** modify the battery pack. This may cause heat generation, and the battery may rupture, emit smoke or catch fire.

⚠ **DANGER!** Use the battery only with the transceiver for which it is specified. Never use a battery with any other equipment, or for any purpose that is not described in this instruction manual.

⚠ **DANGER!** If fluid from inside the battery gets in your eyes, blindness can result. Rinse your eyes with clean water, without rubbing them, and see a doctor immediately.

8 BATTERY CHARGING

WARNING! Immediately stop using the battery if it emits an abnormal odor, heats up, or is discolored or deformed. If any of these conditions occur, contact your Icom dealer or distributor.

WARNING! Immediately wash, using clean water, any part of the body that comes into contact with fluid from inside the battery.

WARNING! NEVER put the battery in a microwave oven, high-pressure container, or in an induction heating cooker. This could cause overheating, a fire, or cause the battery to rupture.

CAUTION! Always use the battery within the specific temperature range for the transceiver (-20°C to $+60^{\circ}\text{C}$; -4°F to $+140^{\circ}\text{F}$) and the battery itself (-20°C to $+60^{\circ}\text{C}$; -4°F to $+140^{\circ}\text{F}$). Using the battery out of its specific temperature range will reduce the battery's performance and battery life.

CAUTION! Shorter battery life could occur if the battery is left fully charged, completely discharged, or in an excessive temperature environment (above $+50^{\circ}\text{C}$; $+122^{\circ}\text{F}$) for an extended period of time. If the battery must be left unused for a long time, it must be detached from the radio after discharging. You may use the battery until the remaining capacity is about half, then keep it safely in a cool dry place with the temperature range as below;

-20°C to $+50^{\circ}\text{C}$ (-4°F to $+122^{\circ}\text{F}$) (within a month)

-20°C to $+35^{\circ}\text{C}$ (-4°F to $+95^{\circ}\text{F}$) (within three months)

-20°C to $+20^{\circ}\text{C}$ (-4°F to $+68^{\circ}\text{F}$) (within a year)

◇ Charging caution

⚠ **DANGER! NEVER** charge the battery pack in areas with extremely high temperatures, such as near fires or stoves, inside a sun-heated car, or in direct sunlight. In such environments, the safety/protection circuit in the battery will activate, causing the battery to stop charging.

WARNING! DO NOT charge or leave the battery in the battery charger beyond the specific time for charging. If the battery is not completely charged by the specific time, stop charging and remove the battery from the battery charger. Continuing to charge the battery beyond the specific time limit may cause a fire, overheating, or the battery may rupture.

WARNING! NEVER insert the transceiver (battery attached to the transceiver) into the charger if it is wet or soiled. This could corrode the battery charger terminals or damage the charger. The charger is not waterproof.

CAUTION! DO NOT charge the battery outside of the specific temperature range: $\pm 0^{\circ}\text{C}$ to $+40^{\circ}\text{C}$ ($+32^{\circ}\text{F}$ to $+104^{\circ}\text{F}$). Icom recommends charging the battery at $+20^{\circ}\text{C}$ ($+68^{\circ}\text{F}$). The battery may heat up or rupture if charged out of the specific temperature range. Additionally, battery performance or battery life may be reduced.

■ Supplied battery charger

◇ Charging connections

⚡ Do not charge batteries other than the BP-252.

- ① Attach the BC-173 to a flat surface, such as a desk, if desired.
- ② Connect the AC adapter as shown below.
- ③ Insert the battery pack with/without the transceiver into the charger.
 - The charge indicator lights orange.
 - The charge indicator blinks orange (or orange/green alternately) when the protector is activated.
- ④ Charge the battery pack approx. 10 hours, depending on the remaining power condition.
 - The charge indicator lights green when charging is completed.

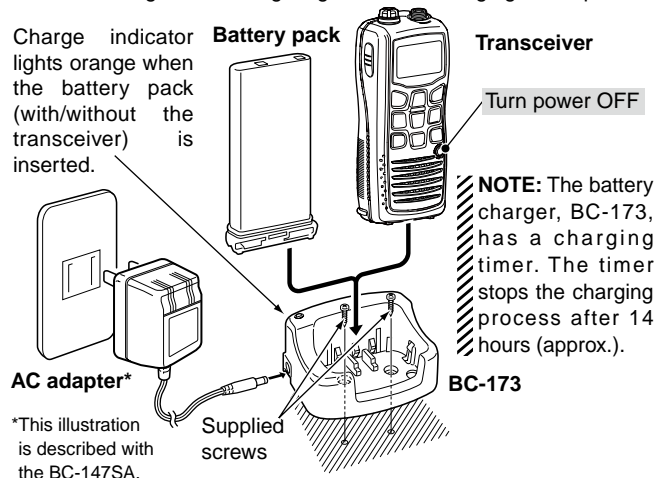

■ Optional battery case

When you would like to use the optional AAA(LR03) size battery case (BP-251), install the batteries as illustrated below. Be sure to observe the correct polarity.

⚡ CAUTION:

- When installing batteries, make sure they are all the same brand, type and capacity. Also, do not mix new and old batteries together.
- Keep battery contacts clean. It's a good idea to clean battery terminals once a week.
- When using the optional battery case, output power level is 2 W (at high).

⚡ NOTE: The transceiver can sink when the optional battery case is attached. (Depends on the weight of the installed batteries.)

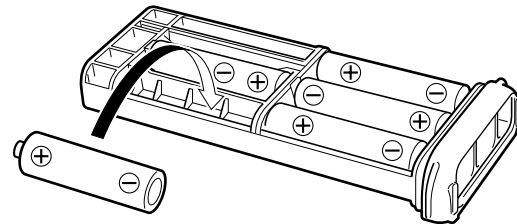

8 BATTERY CHARGING

■ Optional battery charger

◇ BC-162 installation

• To a desktop

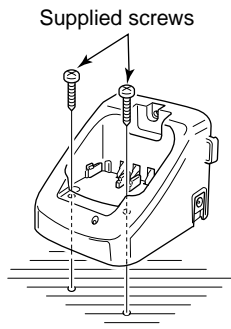

• To a wall

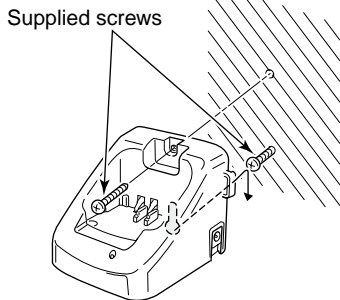

• For added stability

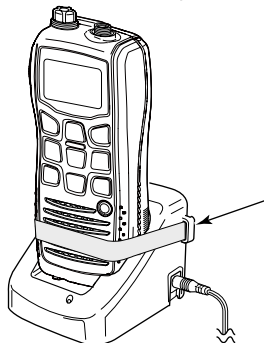

Eyelet:

Use a rubber band to secure the transceiver, if desired.

◇ Charging

- ① Connect the AC adapter as shown below.
- ② Insert the battery pack with/without the transceiver into the charger.
 - The charge indicator lights orange.
 - The charge indicator blinks orange (or red) when the prœctor is activated.
- ③ Charge the battery pack approx. 2 hours, depending on the remaining power condition.
 - The charge indicator lights green when charging is completed.

NOTE: The battery charger, BC-162, has a charging timer. The timer stops the charging process after 4 hours (approx.).

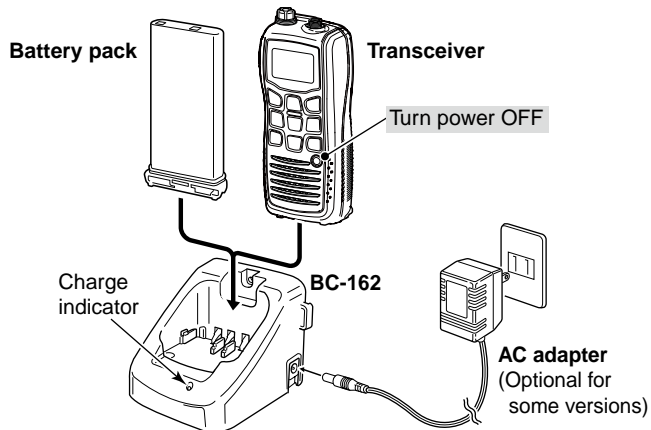

■ HM-165 descriptions

Alligator type clip

To attach the speaker-mic. to your shirt or collar, etc.

PTT switch

Transmits during push.
Receives during release.

Microphone

Speaker

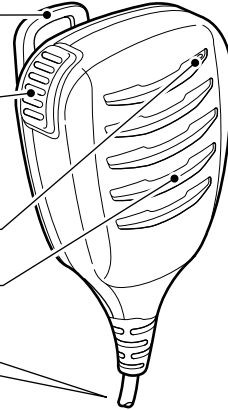

Turn the transceiver power OFF when connecting the HM-165.

NEVER immerse the connector in water. If the connector gets wet, be sure to dry it **BEFORE** attaching it to the transceiver.

NOTE: The microphone is located at the top of the speaker-microphone, as shown above. To maximize the readability of your transmitted signal (voice), hold the microphone approx. 5 to 10 cm (2 to 4 inches) from your mouth, and speak in a normal voice level.

NOTE: When the speaker-microphone is connected to the transceiver, the noise cancellation does not work.

■ Attachment



Turn power OFF before attaching the speaker-microphone. Then, insert the speaker-mic connector into the **[SP MIC]** connector and carefully screw it tight, as shown below. Be careful not to cross-thread the connection.

IMPORTANT: **KEEP** the transceiver's **[SP MIC]** cap attached when the speaker-microphone is not in use. If the cover is not attached, water will get into the transceiver. Moreover, the terminals (pins) will become rusty, or the transceiver will function abnormally if the connector gets wet.

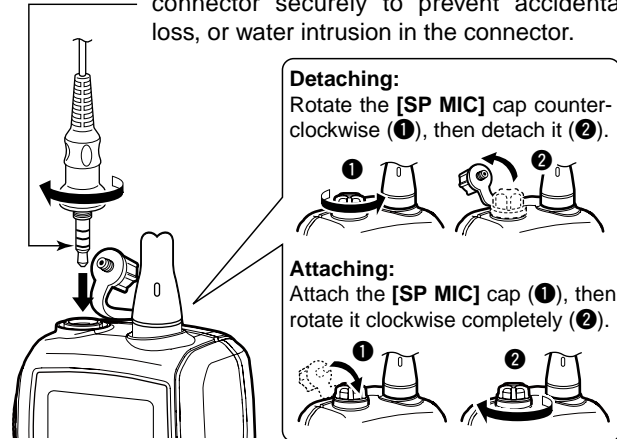
CAUTION: Attach the speaker-microphone's connector securely to prevent accidental loss, or water intrusion in the connector.



10 TROUBLESHOOTING

PROBLEM	POSSIBLE CAUSE	SOLUTION	REF.
The transceiver does not turn ON.	<ul style="list-style-type: none"> The battery is exhausted. The battery pack is not attached correctly. 	<ul style="list-style-type: none"> Recharge the battery pack. Attach the battery pack correctly. 	p. 23 p. 3
No sound from speaker.	<ul style="list-style-type: none"> The squelch level is too high. Volume level is too low. Speaker has been exposed to water. 	<ul style="list-style-type: none"> Set the squelch level to the threshold level. Adjust the audio level to a suitable level. Drain water from the speaker. 	p. 12 p. 11 p. 13
Transmitting is impossible, or high power can not be selected.	<ul style="list-style-type: none"> Some channels are for low power or receive only. The battery is exhausted. The battery is over charged. The output power is set to low. 	<ul style="list-style-type: none"> Change channels. Recharge the battery pack. Make sure the battery voltage is correct. Push [Hi/Lo ] to select high power. 	pgs. 8, 9, 27 p. 23 — p. 10
The displayed channel cannot be changed.	<ul style="list-style-type: none"> Lock function is activated. 	<ul style="list-style-type: none"> Push and hold [Hi/Lo ] for 1 sec. to cancel the function. 	p. 13
Scan does not start.	<ul style="list-style-type: none"> "TAG" channels are not programmed. 	<ul style="list-style-type: none"> Set the desired channels as "TAG" channels. 	p. 15
Emits no beep.	<ul style="list-style-type: none"> Beep tone function is turned OFF. 	<ul style="list-style-type: none"> Set the beep tone to ON (Fix Beep/User Beep) in the set mode. 	p. 18
Battery voltage error.	<ul style="list-style-type: none"> The connected battery pack's voltage is more than 11 V. 	<ul style="list-style-type: none"> Make sure the battery voltage is correct. 	—
The noise cancellation does not work.	<ul style="list-style-type: none"> The sub-microphone is covered with something. An optional external speaker-microphone is connected. 	<ul style="list-style-type: none"> Make sure the sub-microphone is not covered. Disconnect the microphone. 	p. 4 p. 25
The noise detection function does not work.	<ul style="list-style-type: none"> The sub-microphone is covered with something. The squelch is open. 	<ul style="list-style-type: none"> Make sure the sub-microphone is not covered. Set the squelch level to the desired level. 	p. 4 p. 12

VHF MARINE CHANNEL LIST 11

Channel number			Frequency (MHz)	
USA	INT	CAN	Transmit	Receive
	01	01	156.050	160.650
01A			156.050	156.050
	02	02	156.100	160.700
	03	03	156.150	160.750
03A			156.150	156.150
	04		156.200	160.800
		04A	156.200	156.200
	05		156.250	160.850
05A		05A	156.250	156.250
06	06	06	156.300	156.300
	07		156.350	160.950
07A		07A	156.350	156.350
08	08	08	156.400	156.400
09	09	09	156.450	156.450
10	10	10	156.500	156.500
11	11	11	156.550	156.550
12	12	12	156.600	156.600
13*	13	13*	156.650	156.650
14	14	14	156.700	156.700
15*	15*	15*	156.750	156.750
16	16	16	156.800	156.800
17*	17	17*	156.850	156.850
	18		156.900	161.500
18A		18A	156.900	156.900
	19		156.950	161.550
19A		19A	156.950	156.950
20	20	20*	157.000	161.600
20A			157.000	157.000

Channel number			Frequency (MHz)	
USA	INT	CAN	Transmit	Receive
	21	21	157.050	161.650
21A		21A	157.050	157.050
		21b	Rx only	161.650
	22		157.100	161.700
22A		22A	157.100	157.100
	23	23	157.150	161.750
23A			157.150	157.150
24	24	24	157.200	161.800
25	25	25	157.250	161.850
		25b	Rx only	161.850
26	26	26	157.300	161.900
27	27	27	157.350	161.950
28	28	28	157.400	162.000
		28b	Rx only	162.000
	60	60	156.025	160.625
	61		156.075	160.675
61A		61A	156.075	156.075
	62		156.125	160.725
		62A	156.125	156.125
	63		156.175	160.775
63A			156.175	156.175
	64	64	156.225	160.825
64A		64A	156.225	156.225
	65		156.275	160.875
65A	65A	65A	156.275	156.275
	66		156.325	160.925
66A	66A	66A*	156.325	156.325
67*	67	67	156.375	156.375

Channel number			Frequency (MHz)	
USA	INT	CAN	Transmit	Receive
68	68	68	156.425	156.425
69	69	69	156.475	156.475
70	70	70	RX only	156.525
71	71	71	156.575	156.575
72	72	72	156.625	156.625
73	73	73	156.675	156.675
74	74	74	156.725	156.725
75*	75*	75*	156.775	156.775
76*	76*	76*	156.825	156.825
77*	77	77*	156.875	156.875
	78		156.925	161.525
78A		78A	156.925	156.925
	79		156.975	161.575
79A		79A	156.975	156.975
	80		157.025	161.625
80A		80A	157.025	157.025
	81		157.075	161.675
81A		81A	157.075	157.075
	82		157.125	161.725
82A		82A	157.125	157.125
	83	83	157.175	161.775
83A		83A	157.175	157.175
		83b	Rx only	161.775
84	84	84	157.225	161.825
84A			157.225	157.225
85	85	85	157.275	161.875
85A			157.275	157.275
86	86	86	157.325	161.925

Channel number			Frequency (MHz)	
USA	INT	CAN	Transmit	Receive
86A			157.325	157.325
87	87	87	157.375	161.975
87A			157.375	157.375
88	88	88	157.425	162.025
88A			157.425	157.425

WX channel	Frequency (MHz)	
	Transmit	Receive
1	RX only	162.550
2	RX only	162.400
3	RX only	162.475
4	RX only	162.425
5	RX only	162.450
6	RX only	162.500
7	RX only	162.525
8	RX only	161.650
9	RX only	161.775
10	RX only	163.275

* Low power only.

NOTE: Simplex channels, 3, 21, 23, 61, 64, 81, 82 and 83 **CANNOT** be lawfully used by the general public in U.S.A. waters.

10
11

12 SPECIFICATIONS AND OPTIONS

■ Specifications

◇ GENERAL

- Frequency coverage : Transmit 156.025–157.425 MHz
Receive 156.050–163.275 MHz
- Mode : FM (16K0G3E)
- Channel spacing : 25 kHz
- Power supply requirement : BP-251 and BP-252 only
- Current drain (at 7.4 V DC) : TX (6 W/1 W) 1.5 A/0.7 A typical
Max. audio 0.3 A typical (internal speaker)
0.2 A typical (external speaker)
Power save 10 mA typical
- Frequency stability : ±10 ppm
- Operating temperature range : –20°C to +60°C; –4°F to +140°F
- Dimensions : 62 (W) × 139.5 (H) × 43 (D) mm
(projections not included) 2⁷/₁₆ (W) × 5¹/₂ (H) × 1¹¹/₁₆ (D) inch
- Weight : Approx. 295 g; 10.4 oz
(incl. BP-252, FA-SC58V and MB-109)

◇ TRANSMITTER

- Output power (at 7.4 V DC) : 6 W (High) and 1 W (Low)
- Modulation system : Variable reactance frequency modulation
- Maximum frequency deviation : ±5 kHz
- Adjacent channel power : 70 dB
- Spurious emissions : –68 dBc typical

◇ RECEIVER

- Receive system : Double-conversion superheterodyne
- Sensitivity (12 dB SINAD) : 0.25 μV typical
- Squelch sensitivity : 0.35 μV typical (at threshold)
- Intermodulation : 70 dB typical
- Spurious response : 70 dB typical
- Adjacent channel selectivity : 70 dB typical
- Audio output power (at 10% distortion)
 - Internal speaker : 0.70 W typical with a 16 Ω load
 - External speaker : 0.35 W typical with an 8 Ω load

All stated specifications are subject to change without notice or obligation.

■ Options

◇ BATTERY CASE AND PACK

- **BP-251**BATTERY CASE
Battery case for 5 × AAA (LR03) alkaline cells.
Output power level: 2 W
- **BP-252**Li-Ion BATTERY PACK
7.4 V/980 mAh Li-Ion battery pack.

◇ CHARGERS

- **BC-173**DESKTOP CHARGER + **BC-147SA/BC-174E** AC ADAPTER
Used for regular charging of battery pack. An AC adapter is supplied with the charger depending on the version.
Charging time: approx. 10 hours
- **BC-162**DESKTOP CHARGER + **BC-145*** AC ADAPTER
Used for rapid charging of battery pack.
Charging time: approx. 2 hours.
*Not supplied with some versions.

◇ BELT CLIPS

- **MB-109**BELT CLIP
The same as supplied with the transceiver.

◇ OTHER OPTIONS

- **HM-165**SPEAKER-MICROPHONE
Full sized speaker-microphone including an alligator clip to attach the microphone to your shirt, collar, etc. The HM-165 meets IPX7 requirements for waterproof protection. However, once it has been dropped, the IP rating cannot be guaranteed because of possible damage to its case or the waterproof seal.
- **FA-SC58V**ANTENNA

Icom optional equipment is designed for optimal performance when used with this transceiver. We are not responsible for the transceiver being damaged or any accident caused when using non-Icom optional equipment.

FOR CLASS B UNINTENTIONAL RADIATORS

This equipment has been tested and found to comply with the limits for a Class B digital device, pursuant to part 15 of the FCC Rules. These limits are designed to provide reasonable protection against harmful interference in a residential installation. This equipment generates, uses and can radiate radio frequency energy and, if not installed and used in accordance with the instructions, may cause harmful interference to radio communications. However, there is no guarantee that interference will not occur in a particular installation. If this equipment does cause harmful interference to radio or television reception, which can be determined by turning the equipment off and on, the user is encouraged to try to correct the interference by one or more of the following measures:

- Reorient or relocate the receiving antenna.
- Increase the separation between the equipment and receiver.
- Connect the equipment into an outlet on a circuit different from that to which the receiver is connected.
- Consult the dealer or an experienced radio/TV technician for help.

Count on us!

A-6710H-1EX-①a
Printed in Japan
© 2008 Icom Inc.

Printed on recycled paper with soy ink.

Icom Inc.
1-1-32 Kamiminami, Hirano-ku, Osaka 547-0003, Japan